

# L-Squares



## L-Squares without brace

made of high-quality material with two pegs made of blue plastic allowing the glass edge to be fully visible when positioned

Art. No.	length (cm)	width (cm)	colour
029.00	30	17	without pegs - black
029.5	30	17	black
030.5	50	27	grey
031.5	60	27	grey
032.5	80	37	grey
033.5	105	37	grey
034.5	135	47	grey
035.5	150	47	grey
036.5	175	47	grey



## L-Squares with brace - black

made from one piece of high-quality material

Art. No.	length (cm)	width (cm)
031.1	60	30
032.1	80	34
033.1	105	40
034.1	135	45
035.1	150	45
036.1	175	50
037.1	205	60
038.1	250	70



## Joiner's Square

with mitre, with two graduations

### light version

steel blade 30 mm



Art. No.	length (mm)
1020150	150
1020200	200
1020250	250
1020300	300
1020350	350
1020400	400

### heavy version

steel blade 35 mm

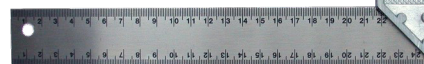

Art. No.	length (mm)
1110150	150
1110200	200
1110250	250
1110300	300
1110350	350
1110400	400

## Steel Square

carbon steel, zinc plated

### without back



Art. No. w/o back	blade width (mm)	size (mm)
1200100	20	100 x 70
1200150	20	150 x 100
1200200	20	200 x 130
1200250	25	250 x 160
1200300	25	300 x 180
1200400	25 / 30	400 x 230
1200500	25 / 30	500 x 280
1200600	30	600 x 330
1200800	30	800 x 430
1201000	30	1000 x 500

### with back



Art. No. with back	blade width (mm)	size (mm)
1300100	20	100 x 70
1300150	20	150 x 100
1300200	20	200 x 130
1300250	25	250 x 160
1300300	25	300 x 180
1300400	25	400 x 230
1300500	25	500 x 280
1300600	30	600 x 330
1300800	30	800 x 430
1301000	30	1000 x 500

## Squares



### Try Square - Powder Coated

made of hardened spring steel, 40 x 1.2 mm, with mm-graduation.  
support blade made of black anodised aluminium profile, L-form 40 x 14 mm.  
powder coated in yellow (RAL 1021).

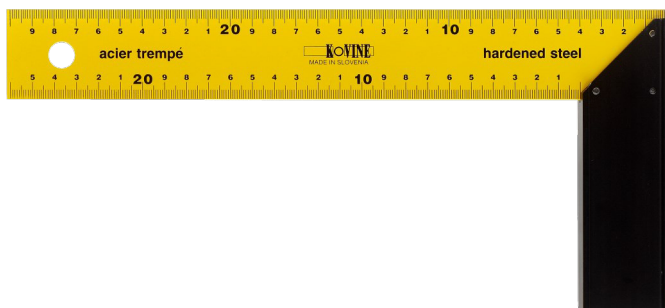

Art. No.	dimensions (mm)
KMI200	200 x 125
KMI250	250 x 135
KMI300	300 x 135
KMI350	350 x 190
KMI400	400 x 190
KMI500	500 x 210

### Carpenter's Square - Powder Coated

made of hardened spring steel, 35 x 1.5 mm, with mm-graduation.  
powder coated in yellow (RAL 1021).

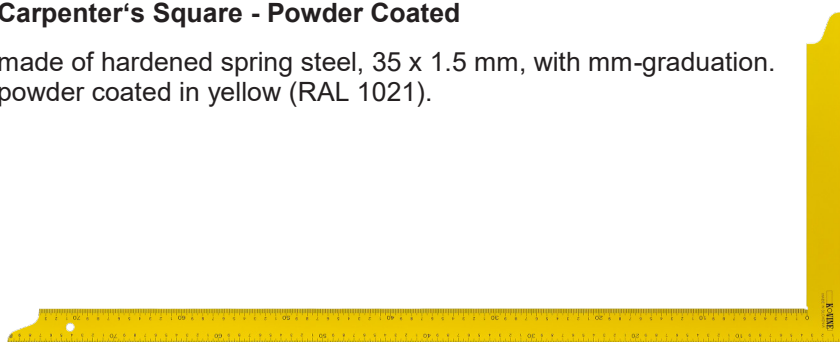

Art. No.	dimensions (mm)
KTB500	500 x 250
KTB600	600 x 280
KTB700	700 x 300
KTB800	800 x 320
KTB900	900 x 340
KTB1000	1000 x 360

### Carpenter's Square - Powder Coated

made of hardened spring steel, 35 x 1.5 mm, with mm-graduation.  
zinc coated.

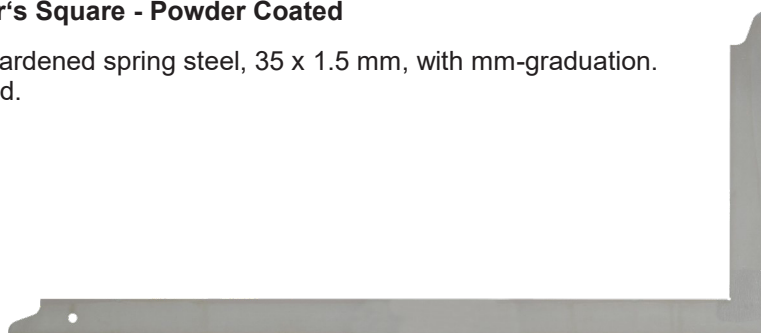

Art. No.	dimensions (mm)
KTC500	500 x 250
KTC600	600 x 280
KTC700	700 x 300
KTC800	800 x 320
KTC900	900 x 340
KTC1000	1000 x 360

### Try Square 45° - Powder Coated

made of hardened spring steel, 40 x 1.2 mm.  
support blade made of black anodised aluminium profile, L-form 40 x 1.4 mm.  
for measuring of angles 45° and 135°. Powder coated in yellow (RAL 1021).



Art. No.	length (mm)
KMS250	250

## Clamps & Joiner's Squares



### Joiner's Squares

with die-cast stock and mm-graduation,  
light execution,  
steel blade 32 mm - INOX blade 30 mm

Art. No.	length (mm)	Art. No. INOX	length (mm)	Material
123120	200	122120	200	stainless steel blade
123125	250	122125	250	stainless steel blade
123130	300	122130	300	stainless steel blade
123135	350			
123140	400			

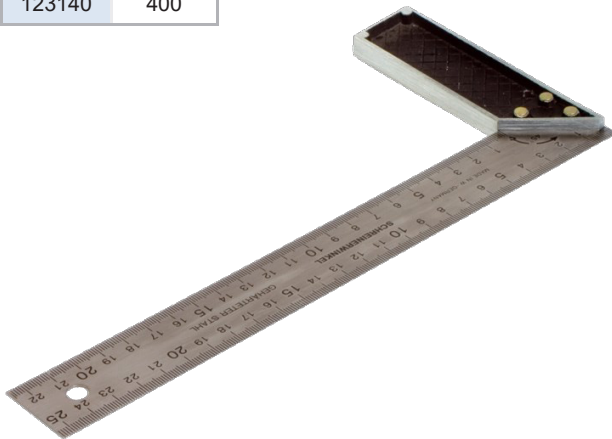

### Joiner's Squares

with beech wood stock, blue steel blade and  
mm-graduation  
blade 40 mm

Art. No.	length (mm)
102125	250
102130	300
102140	400

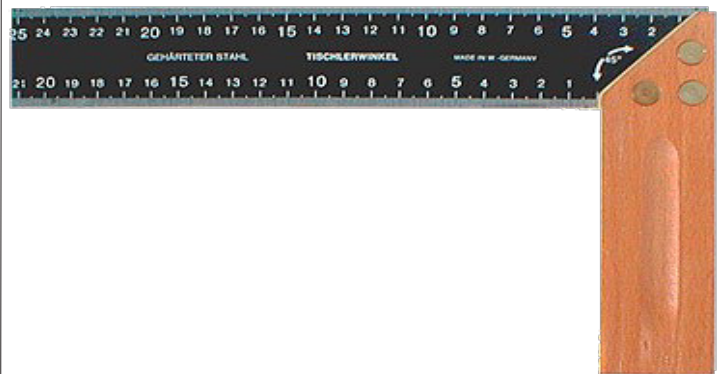

### BESSEY Door Clamps

with T-profile  
colour: black

Art. No. Type A	Art. No. Type B	length
TAN 80		800
	TB 100	1000
TAN 120	TB 120	1200
TAN 150	TB 150	1500
TAN 210	TB 210	2100
TAN 250	TB 250	2500

**A)** Sash clamp TAN with L-profile, 80 x 42 x 3.9 mm, easy adjustable jaws, with stopping bolt, Type TAN - force 24.000 N

**B)** Sash clamp TB with T-profile 40 x 40 x 5 mm with locking bolt, Type TB - force 14.000N

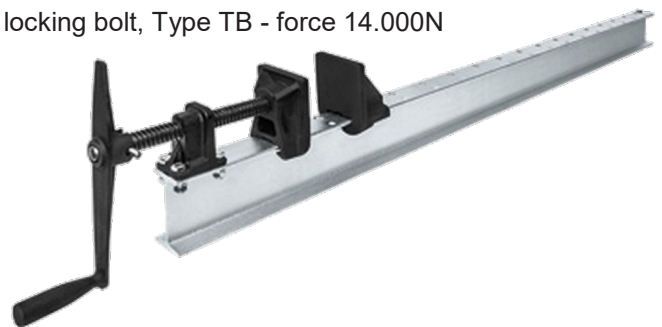

### KISTENMACHER brand C-Clamps

made of high grade, drop forged steel, galvanized  
with fine thread spindle

Art. No.	Clamping	throat
420-028	28	25
420-053	53	38
420-078	78	50
420-105	105	60
420-130	130	70
420-155	155	76
420-206	206	86

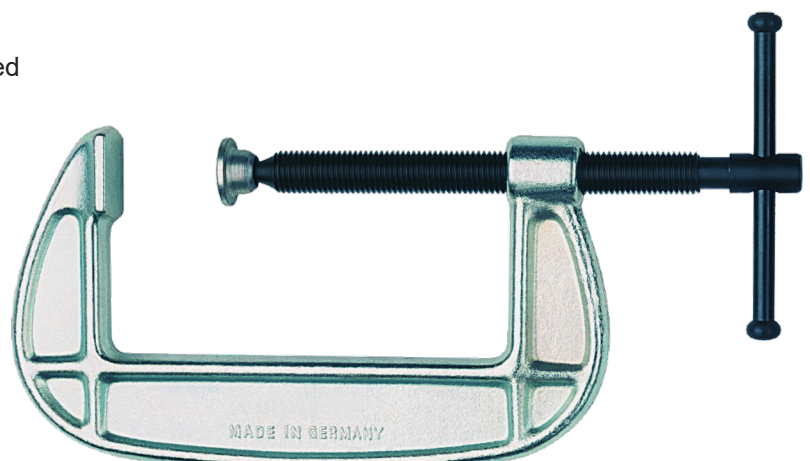

## F-Clamps



**KISTENMACHER brand cast iron F-Clamps,**  
galvanized grooved hollow section bar,  
black clamp,  
with red coloured wooden handle and protective caps

Art. No.	size (mm)	rail (mm)
21100	100x50	15x5
21101	120x60	22x6
21102	160x80	25x6
21103	200x100	30x8
21104	250x120	30x8
21105	300x140	35x9
21106	400x175	35x9
21199	400x120	35x11
21200	500x120	35x11
21201	600x120	35x11
21202	800x120	35x11
21203	1000x120	35x11
21204	1250x120	35x11
21205	1500x120	35x11
21206	2000x120	35x11
21207	2500x120	35x11
21208	3000x120	35x11



**KISTENMACHER brand cast iron F-Clamps,**  
galvanized grooved hollow section bar,  
silver galvanized clamp,  
with red coloured wooden handle and protective caps

Art. No.	size (mm)	rail (mm)
11100	100x50	15x5
11101	120x60	22x6
11102	160x80	25x6
11103	200x100	30x8
11104	250x120	30x8
11105	300x140	35x9
11106	400x175	35x9
11199	400x120	35x11
11200	500x120	35x11
11201	600x120	35x11
11202	800x120	35x11
11203	1000x120	35x11
11204	1250x120	35x11
11205	1500x120	35x11
11206	2000x120	35x11
11207	2500x120	35x11
11208	3000x120	35x11



**KISTENMACHER brand cast iron F-Clamps,**  
galvanized grooved hollow section bar,  
black clamp, with blue-black coloured  
Power-Grip handle and protective caps

Art. No.	size (mm)	rail (mm)
22100	100x50	15x5
22101	120x60	22x6
22102	160x80	25x6
22103	200x100	30x8
22104	250x120	30x8
22105	300x140	35x9
22106	400x175	35x9
22199	400x120	35x11
22200	500x120	35x11
22201	600x120	35x11
22202	800x120	35x11
22203	1000x120	35x11
22204	1250x120	35x11
22205	1500x120	35x11
22206	2000x120	35x11
22207	2500x120	35x11
22208	3000x120	35x11



**KISTENMACHER brand cast iron F-Clamps,**  
galvanized grooved hollow section bar,  
silver galvanized clamp, with blue-black coloured  
Power-Grip and protective caps

Art. No.	size (mm)	rail (mm)
52100	100x50	15x5
52101	120x60	22x6
52102	160x80	25x6
12103	200x100	30x8
12104	250x120	30x8
12105	300x140	35x9
12106	400x175	35x9
12199	400x120	35x11
52200	500x120	35x11
52201	600x120	35x11
52202	800x120	35x11
12203	1000x120	35x11
12204	1250x120	35x11
12205	1500x120	35x11
12206	2000x120	35x11
12207	2500x120	35x11
12208	3000x120	35x11

